

Varenummer: 392211003055036
 Beskrivelse: Snekkegear med skridnav
 W110 L2-UFC-30-P132 B5

Mål

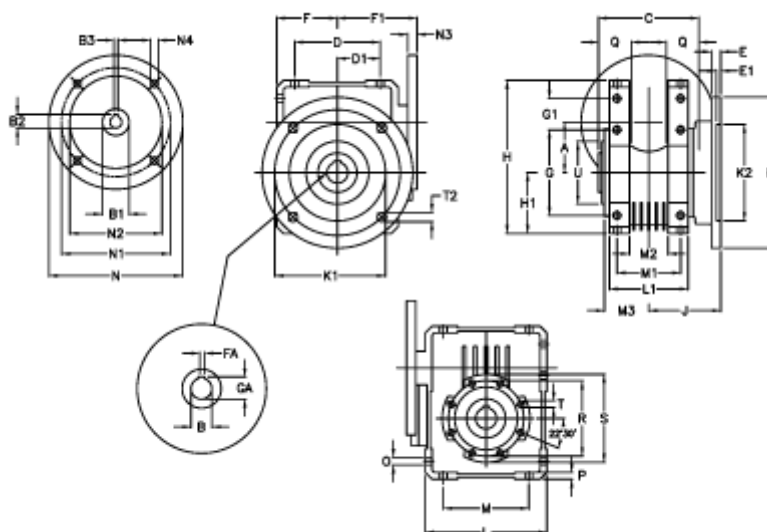

A = 110.10	E = 20	H = 308.0	M = 184	N4 = 13	U = 130
B = 42	E1 = 12	H1 = 125.0	M1 = 115	O = 14.0	
B1 E7 = 38	F = 125	J = 131.5	M2 = 69	P = 14	
B2 = 41.3	F1 = 226	K = 280	M3 = 73.0	Q = 45	
B3 H9 = 10	FA = 12	K1 = 230	N = 300	R = 165	
C = 155	G = 184	K2 = 170	N1 = 265	S = 200	
D = 174.0	G1 = 58.0	L = 250	N2 = 230	T = M12x19	
D1 = 82.0	GA = 45.3	L1 = 143	N3 = 16	T2 = 13.0	